

Air Pilot Valves



LOW PRESSURE AIR PILOT VALVES

- N.O. or N.C. air pilot valves
- Amplifier valves
- Bleed pressure piloted limit valves
- Electronically piloted valves

pp. 96-97



BRASS AIR PILOT VALVES

- PAV/PAVO Series
- Normally-Open or Normally-Closed
- 2-Way and 3-Way configurations

p. 98



MAXIMATIC® AIR PILOT VALVES

- Spool type valves with single or double air pilots
- Maximum flow, maximum value
- 3-Way and 4-Way configurations

pp. 99-101



MODULAR VALVES

- Available in an unlimited variety of directional, low pressure, and special control valves
- The supreme "plug-and-play" devices for pneumatic applications

pp. 102-113

PROBLEM

Sometimes, it's all about the timing. In this case, a retrofit to an old machine was needed—fast! The OEM sought a partner who could help modify an existing design and meet a tight deadline.

SOLUTION

In these types of situations, the Clippard modular valve works wonders. These valves mount and link together with a special piping system which eases assembly and plumbing, provides reduced labor costs, minimizes errors in installation, and eliminates potential leak points. Clippard modular valves have been uniquely designed to enable multiple valve elements to be contained within a single valve body. This provides incredible flexibility and variety, allowing Clippard modular valves to accomplish a myriad of control challenges.

In this case, Clippard modular valves were specially configured to meet the requirements of this particular application and mounted on a special acrylic subplate, thereby greatly simplifying redundant circuitry. The OEM's new circuit improved the performance and maintenance of their system and shipped in time to meet their deadline.

WHAT CAN CLIPPARD DO FOR YOU?

877-245-6247



LOW PRESSURE AIR PILOT VALVES

3-WAY N.C. AMPLIFIER VALVES



Amplifies very low pressure air-jet sensing signals to working power levels

Part No.	Description
2010	Normally-Closed Interface, 1/8" NPT
2010-050	Flat Mounting Bracket

Medium	Air
Material	Anodized aluminum body, nitrile diaphragms
Input Pressure	30 to 100 psig
Air Flow	620 l/min @ 100 psig
Pilot Pressure	4" H ₂ O @ 100 psig
Max. Pilot Pressure	5 psig
Filtration	10 micron
Response Time	10 ms dead headed
Operating Speed	50 Hz
Bleed	2.8 l/min @ 100 psig
Ports	Load, Supply & Exhaust: 1/8" NPT female Control: #10-32 female

3-WAY BLEED PRESSURE PILOTED LIMIT VALVES



Blocking of the sensing port causes rapid valve opening

Part No.	Description
2011	Piloted Limit Valve, 1/8" NPT
2011-012	Replacement #10-32 rubber nozzles
2010-050	Flat Mounting Bracket

Medium	Air
Material	Anodized aluminum body, nitrile diaphragms
Input Pressure	30 to 100 psig max.
Air Flow	620 l/min @ 100 psig
Filtration	10 micron
Bleed	2.8 l/min @ 100 psig
Response Time	15 ms
Ports	1/8" NPT

3-WAY N.O. OR N.C. AIR PILOT VALVES



Blocking of the sensing port causes rapid valve opening

Part No.	Description
2012	Piloted Valve, 1/8" NPT
2012-VAC	Valve for Vacuum Operation <i>Requires positive pressure pilot signal</i>
2012-G	Valve for Liquid Adhesives <i>Silicone diaphragm and seals, 1/8" NPT</i>
2010-050	Flat Mounting Bracket

Medium	Air
Material	Anodized aluminum body, nitrile diaphragms
Input Pressure	1 to 100 psig max.
Air Flow	620 l/min @ 100 psig
Pilot Pressure	20 psig min. or N.O. 90% of Supply, N.C. 60% of Supply (<i>whichever is greater</i>)
Response Time	15 ms after pilot pressure reaches switch point
Operating Speed	1,100 CPM

LOW PRESSURE AIR PILOT VALVES

3-WAY N.O. OR N.C. ELECTRONICALLY PILOTED VALVES



Low-power DC solenoid can be directly converted to high pressure pneumatic power without electronic amplification.

Part No.	Description
2013-6	Valve, 6 VDC, 1/8" NPT
2013-12	Valve, 12 VDC, 1/8" NPT
2013-24	Valve, 24 VDC, 1/8" NPT
2010-050	Flat Mounting Bracket

Medium	Air
Material	Anodized aluminum body, nitrile diaphragms
Input Pressure	30 to 100 psig max.
Air Flow	620 l/min @ 100 psig
Bleed	2.8 l/min @ 100 psig
Filtration	10 micron
Frequency Response	50 Hz @ 100 psig; 70 Hz @ 30 psig
Switching Speed	10 ms
Leads	28 gauge stranded PVC insulated
Continuous Overload	350% @ 25°C; 250% @ 50°C (ambient)
Power Consumption	< 0.50 W at rated voltage 80 ma. @ 6V, 40 ma. @ 12V, 20 ma. @ 24V

PRESSURE PILOTED SNAP ACTION AMPLIFYING VALVE



Provides a sharp, clean output signal, even with slow-changing pressure input signals; output is stabilized without chatter or oscillation.

Part No.	Description
3200-A	Amplifying Valve, #10-32
3200-006	Mounting Bracket

Medium	Air
Input Pressure	3 to 100 psig max.
Min. Pilot Pressure	1.5" H ₂ O
Max. Pilot Pressure	1 psig (28" H ₂ O)
Air Flow	5.1 l/min @ 100 psig;
Bleed Orifice	0.010" diameter

3-WAY N.C. PRESSURE PILOTED VALVES



Designed to be piloted by a Clippard EV or ET manifold mount electronic valve. Output from the EV/ET actuates the valve to produce outputs up to 620 l/min at 100 psig. Combines low wattage, long life and cool running of the EV/ET valves with quick response and high flow of Clippard booster type valves.

Part No.	Description
2020	Piloted Valve, External Port
2021	Piloted Valve, Internal Port
2010-050	Flat Mounting Bracket

Medium	Air
Input Pressure	30 to 100 psig max.
Air Flow	620 l/min @ 100 psig
Pilot Pressure	60% of supply pressure, minimum
Response Time	Approx. 20 milliseconds
Mounting	Mounting holes provided
Materials	Anodized aluminum, stainless steel

The 2020 has an external #10-32 port for the pressure supply to the EV/ET electronic pilot valve. The 2021 has an internal pressure supply to the EV/ET.

2-WAY & 3-WAY AIR PILOT VALVES

PAV/PAVO SERIES

These Normally-Open or Normally-Closed 2-Way and 3-Way valves incorporate an integral pilot actuator that provides a compact assembly and simple installation. The internal valving is identical to the MAV-2/3 or MAVO-2/3.

Medium	Air, water, or oil
Input Pressure	PAV-2/3: 300 psig PAVO-2/3: 150 psig max.
Air Pilot Pressure	15 psig min.
Air Flow	PAV-2/3: 113 l/min @ 50 psig; 190 l/min @ 100 psig PAVO-2/3: 190 l/min @ 50 psig; 330 l/min @ 100 psig
Mounting	5/8-32 thread or #4 screw
Materials	Brass body, nitrile seals, stainless steel stem and spring
Accessories	Foot Bracket: FB-1791 Nut and Lockwasher: PAV-MH

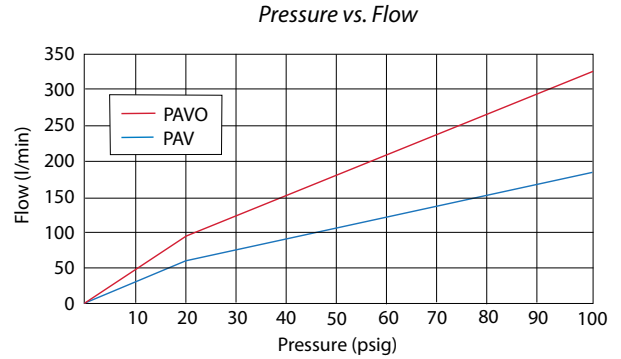

Air pilot valves are ideal for remote and miniature applications which require higher air flow and/or lower power

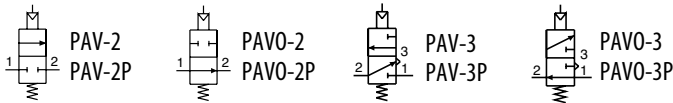

NORMALLY-CLOSED POPPET VALVES

Port(s)	2-Way	3-Way
#10-32 1/8" NPT	PAV-2 PAV-2P	PAV-3 PAV-3P



PAV-2P shown

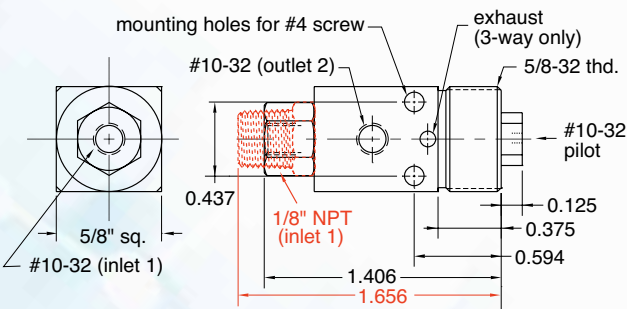

NORMALLY-OPEN SPOOL VALVES

Port(s)	2-Way	3-Way
#10-32 1/8" NPT	PAVO-2 PAVO-2P	PAVO-3 PAVO-3P



PAVO-2 shown

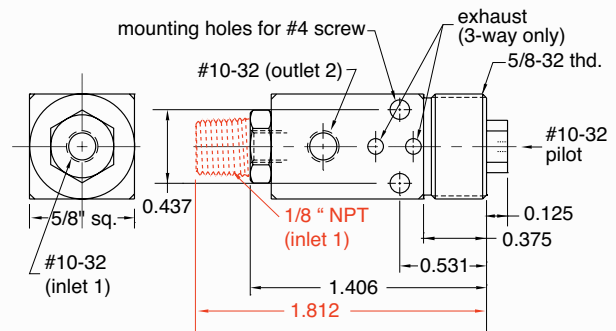

MAXIMATIC® SERIES AIR PILOT VALVES

ORDERING GUIDE



3-WAY VALVES

Series No.	Inlet	Outlet	Exhaust	Ports/Position	Cv	Flow @ 100 psig	Page
MMA-31NAS	#10-32	#10-32	#10-32	3/2	0.58	760 l/min	100
MMA-31PAS	1/8" NPT	1/8" NPT	1/8" NPT	3/2	0.67	880 l/min	100
MMA-32QAS	1/4" NPT	1/4" NPT	1/8" NPT	3/2	0.89	1,400 l/min	100
MMA-33WAS	3/8" NPT	3/8" NPT	1/4" NPT	3/2	1.68	2,600 l/min	100
MMA-34ZAS	1/2" NPT	1/2" NPT	1/2" NPT	3/2	2.79	4,800 l/min	100
MMA-31NAA	#10-32	#10-32	#10-32	3/2	0.58	760 l/min	100
MMA-31PAA	1/8" NPT	1/8" NPT	1/8" NPT	3/2	0.67	880 l/min	100
MMA-32QAA	1/4" NPT	1/4" NPT	1/8" NPT	3/2	0.89	1,400 l/min	100
MMA-33WAA	3/8" NPT	3/8" NPT	1/4" NPT	3/2	1.68	2,600 l/min	100
MMA-34ZAA	1/2" NPT	1/2" NPT	1/2" NPT	3/2	2.79	4,800 l/min	100

4-WAY VALVES

Series No.	Inlet	Outlet	Exhaust	Ports/Position	Cv	Spool Configuration			
						Flow @ 100 psig	Closed Center	Exhaust Center	Pressure Center
MMA-41NAS	#10-32	#10-32	#10-32	5/2	0.58	760 l/min			
MMA-41PAS	1/8" NPT	1/8" NPT	1/8" NPT	5/2	0.67	880 l/min			
MMA-42QAS	1/4" NPT	1/4" NPT	1/8" NPT	5/2	0.89	1,400 l/min			
MMA-43WAS	3/8" NPT	3/8" NPT	1/4" NPT	5/2	1.68	2,600 l/min			
MMA-44ZAS	1/2" NPT	1/2" NPT	1/2" NPT	5/2	2.79	4,800 l/min			
MMA-41NAA	#10-32	#10-32	#10-32	5/2	0.58	760 l/min			
MMA-41PAA	1/8" NPT	1/8" NPT	1/8" NPT	5/2	0.67	880 l/min			
MMA-42QAA	1/4" NPT	1/4" NPT	1/8" NPT	5/2	0.89	1,400 l/min			
MMA-43WAA	3/8" NPT	3/8" NPT	1/4" NPT	5/2	1.68	2,600 l/min			
MMA-44ZAA	1/2" NPT	1/2" NPT	1/2" NPT	5/2	2.79	4,800 l/min			
MMA-41NAAC	#10-32	#10-32	#10-32	5/3	0.50	650 l/min	•		
MMA-41PAAC	1/8" NPT	1/8" NPT	1/8" NPT	5/3	0.50	650 l/min	•		
MMA-42QAAC	1/4" NPT	1/4" NPT	1/8" NPT	5/3	0.89	1,400 l/min	•		
MMA-43WAAC	3/8" NPT	3/8" NPT	1/4" NPT	5/3	1.00	2,000 l/min	•		
MMA-44ZAAC	1/2" NPT	1/2" NPT	1/2" NPT	5/3	1.68	2,600 l/min	•		
MMA-41NAAP	#10-32	#10-32	#10-32	5/3	0.50	650 l/min			•
MMA-41PAAP	1/8" NPT	1/8" NPT	1/8" NPT	5/3	0.50	650 l/min			•
MMA-42QAAP	1/4" NPT	1/4" NPT	1/8" NPT	5/3	0.89	1,400 l/min			•
MMA-43WAAP	3/8" NPT	3/8" NPT	1/4" NPT	5/3	1.00	2,000 l/min			•
MMA-44ZAAP	1/2" NPT	1/2" NPT	1/2" NPT	5/3	1.68	2,600 l/min			•
MMA-41NAAE	#10-32	#10-32	#10-32	5/3	0.50	650 l/min		•	
MMA-41PAAE	1/8" NPT	1/8" NPT	1/8" NPT	5/3	0.50	650 l/min		•	
MMA-42QAAE	1/4" NPT	1/4" NPT	1/8" NPT	5/3	0.89	1,400 l/min		•	
MMA-43WAAE	3/8" NPT	3/8" NPT	1/4" NPT	5/3	1.00	2,000 l/min		•	
MMA-44ZAAE	1/2" NPT	1/2" NPT	1/2" NPT	5/3	1.68	2,600 l/min		•	

Maximatic® is a registered trademark of Clippard Instrument Laboratory, Inc.

MAXIMATIC® SERIES AIR PILOT VALVES

3-WAY & 4-WAY VALVES



Maximatic 3-Way and 4-Way air pilot valves are either double pilot or single pilot, spring return in #10-32 thread to 1/2" NPT port sizes. These air pilot valves have 1/8" NPT pilot ports.

Type	Spool (not bidirectional)
Medium	Air (40 micron filtration) or inert gas
Operating Range	Single Air Pilot: 20 to 125 psig Double Air Pilot: 0 to 125 psig <i>Refer to Minimum Pilot Pressure chart (left)</i>
Pilot Pressure	See chart
Maximum Pressure	125 psig
Mounting	Body Ported, Manifold
Materials	Aluminum, Stainless Steel, Thermoplastic
Seals	Nitrile

MINIMUM PILOT PRESSURE

	Single Pilot		Double Pilot		3-Position	
Operating Pressure (psig)	20	80	20	80	20	80
Pilot Pressure (psig)	20	35	5	8	20**	20**

**30 on MMA-41 Series

2-POSITION 3-WAY SPRING RETURN & AIR PILOT VALVES

Spring Return Valves	Double Air Pilot Valves	Inlet	Outlet	Exhaust	l/min*
MMA-31NAS	MMA-31NAA	#10-32	#10-32	#10-32	760
MMA-31PAS	MMA-31PAA	1/8" NPT	1/8" NPT	1/8" NPT	880
MMA-32QAS	MMA-32QAA	1/4" NPT	1/4" NPT	1/8" NPT	1,400
MMA-33WAS	MMA-33WAA	3/8" NPT	3/8" NPT	1/4" NPT	2,600
MMA-34ZAS	MMA-34ZAA	1/2" NPT	1/2" NPT	1/2" NPT	4,800

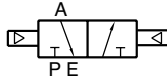

2-POSITION 4-WAY SPRING RETURN & AIR PILOT VALVES

Spring Return Valves	Double Air Pilot Valves	Inlet	Outlet	Exhaust	l/min*
MMA-41NAS	MMA-41NAA	#10-32	#10-32	#10-32	760
MMA-41PAS	MMA-41PAA	1/8" NPT	1/8" NPT	1/8" NPT	880
MMA-42QAS	MMA-42QAA	1/4" NPT	1/4" NPT	1/8" NPT	1,400
MMA-43WAS	MMA-43WAA	3/8" NPT	3/8" NPT	1/4" NPT	2,600
MMA-44ZAS	MMA-44ZAA	1/2" NPT	1/2" NPT	1/2" NPT	4,800

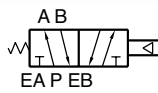

3-POSITION 4-WAY SPRING CENTERED DOUBLE AIR PILOT VALVES

Closed Center, Pressure Center & Exhaust Center



Closed Center	Pressure Center	Exhaust Center	Inlet	Outlet	Exhaust	l/min*
MMA-41NAAC	MMA-41NAAP	MMA-41NAAE	#10-32	#10-32	#10-32	650
MMA-41PAAC	MMA-41PAAP	MMA-41PAAE	1/8" NPT	1/8" NPT	1/8" NPT	650
MMA-42QAAC	MMA-42QAAP	MMA-42QAEE	1/4" NPT	1/4" NPT	1/8" NPT	1,400
MMA-43WAAC	MMA-43WAAP	MMA-43WAAE	3/8" NPT	3/8" NPT	1/4" NPT	2,000
MMA-44ZAAC	MMA-44ZAAP	MMA-44ZAAE	1/2" NPT	1/2" NPT	1/2" NPT	2,600

Conforms to ISO 19973-2 test standards

*Based on flow @ 100 psig

MAXIMATIC® SERIES AIR PILOT VALVE MANIFOLDS

PARALLEL BAR MANIFOLDS & MOUNTING KITS

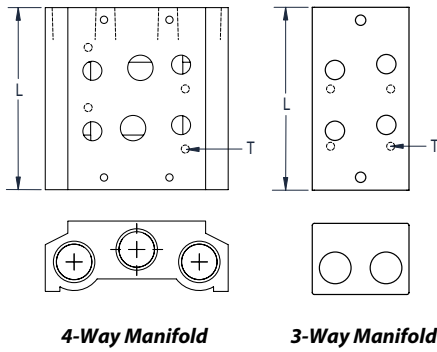

AIR PILOT VALVES

Valve Series	2-Station (L)	4-Station (L)	6-Station (L)	8-Station (L)	16-Station (L)	Thread (T)
MMA-31/41	2.24	3.73	5.25	6.75	12.69	M4
MMA-32/42	2.71	4.50	6.33	8.13	15.38	M4
MMA-33/43	3.22	5.42	7.62	9.82	18.63	M5
MMA-34/44	3.85	6.56	9.38	12.10	23.11	M5

Parallel circuit manifold bars are available for all sizes of MMA 3- and 4-Way valves. Manifolds are made in increments of two stations from two to 16, and are supplied with mounting screws and gaskets. Spare kits are also available which include two screws and a gasket. Blank plate supplied with one gasket, two screws and metal plate.

Valve Series	Manifold Inlet/		2-Station	4-Station	6-Station	8-Station	16-Station
	Exhaust	Blank Plate					
3-Way Valve Manifolds							
MMA-31	1/8"	MMM-31-B	MMM-31-02	MMM-31-04	MMM-31-06	MMM-31-08	MMM-31-16
MMA-32	1/4"	MMM-32-B	MMM-32-02	MMM-32-04	MMM-32-06	MMM-32-08	MMM-32-16
MMA-33	3/8"	MMM-33-B	MMM-33-02	MMM-33-04	MMM-33-06	MMM-33-08	MMM-33-16
MMA-34	1/2"	MMM-34-B	MMM-34-02	MMM-34-04	MMM-34-06	MMM-34-08	MMM-34-16

3-Way Spare Mounting Kit Hardware

27041-31	Hardware Kit for MMA-31 Series Valves	27041-33	Hardware Kit for MMA-33 Series Valves
27041-32	Hardware Kit for MMA-32 Series Valves	27041-34	Hardware Kit for MMA-34 Series Valves

Valve Series	Manifold Inlet/		2-Station	4-Station	6-Station	8-Station	16-Station
	Exhaust	Blank Plate					
4-Way Valve Manifolds							
MMA-41	1/8"	MMM-41-B	MMM-41-02	MMM-41-04	MMM-41-06	MMM-41-08	MMM-41-16
MMA-42	1/4"	MMM-42-B	MMM-42-02	MMM-42-04	MMM-42-06	MMM-42-08	MMM-42-16
MMA-43	3/8"	MMM-43-B	MMM-43-02	MMM-43-04	MMM-43-06	MMM-43-08	MMM-43-16
MMA-44	1/2"	MMM-44-B	MMM-44-02	MMM-44-04	MMM-44-06	MMM-44-08	MMM-44-16

4-Way Spare Mounting Kit Hardware

27041-41	Hardware Kit for MMA-41 Series Valves	27041-43	Hardware Kit for MMA-43 Series Valves
27041-42	Hardware Kit for MMA-42 Series Valves	27041-44	Hardware Kit for MMA-44 Series Valves

MODULAR VALVES

OVERVIEW

Modular valves provide a great deal of versatility with just a few simple components. They consist of essentially three base valve types combined with 18 different options for actuation. As you will see in the proceeding pages, this results in a huge variety of valve options.



BASE VALVE TYPES

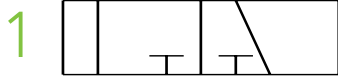

Can be used as:

- 2-Way N.C. or N.O.
- 3-Way N.C. or N.O.
- 3-Way Diverter or Selector



Can be used as:

- 4-Way fully ported
- Dual 2-Way (N.O. and N.C.)
- Dual 3-Way with common exhaust (N.O. and N.C.)



Can be used as:

- 6-Way fully ported
- Dual 2-Way N.C. or N.O.
- Dual 3-Way N.C. or N.O.
- Dual Selector

ACTUATION OPTIONS

Spring Return

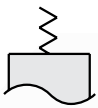

Air Pilot

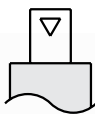

Spring and Auxiliary Pilot



Removable Spring and Auxiliary Pilot

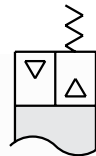

2 Air Pilots "Or"

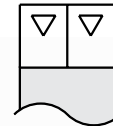

Differential Air Pilots

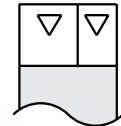

Solenoid Piloted

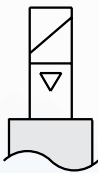

Delay Out from Air Pilot

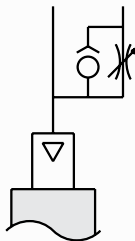

Delay In from Air Pilot

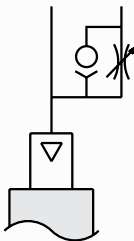

Low Pressure Air Pilot



3 Air Pilots "Or"

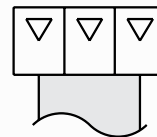

4 Air Pilots "Or"

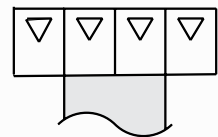

Independent Shuttle Valve and Air Pilot



Shuttle Valve to Air Pilot

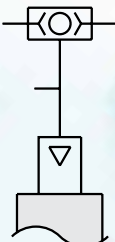

Shuttle Valve to Low Pressure

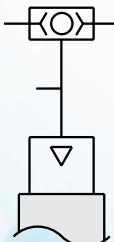

Delay to Air Pilot

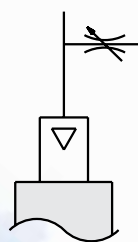

Bleed Pressure Pilot

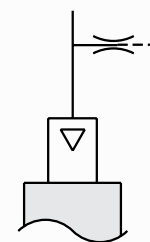

Fluidic Interface Pilot

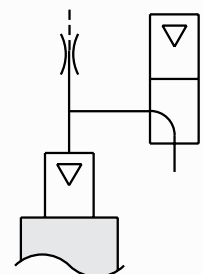

Modular Valves

Versatility is the key when it comes to these supreme "plug-and-play" pneumatic valves. Available in an unlimited variety of directional, low pressure, and special control valves, each is encased in a body designed to mount and link together with a simple piping system.

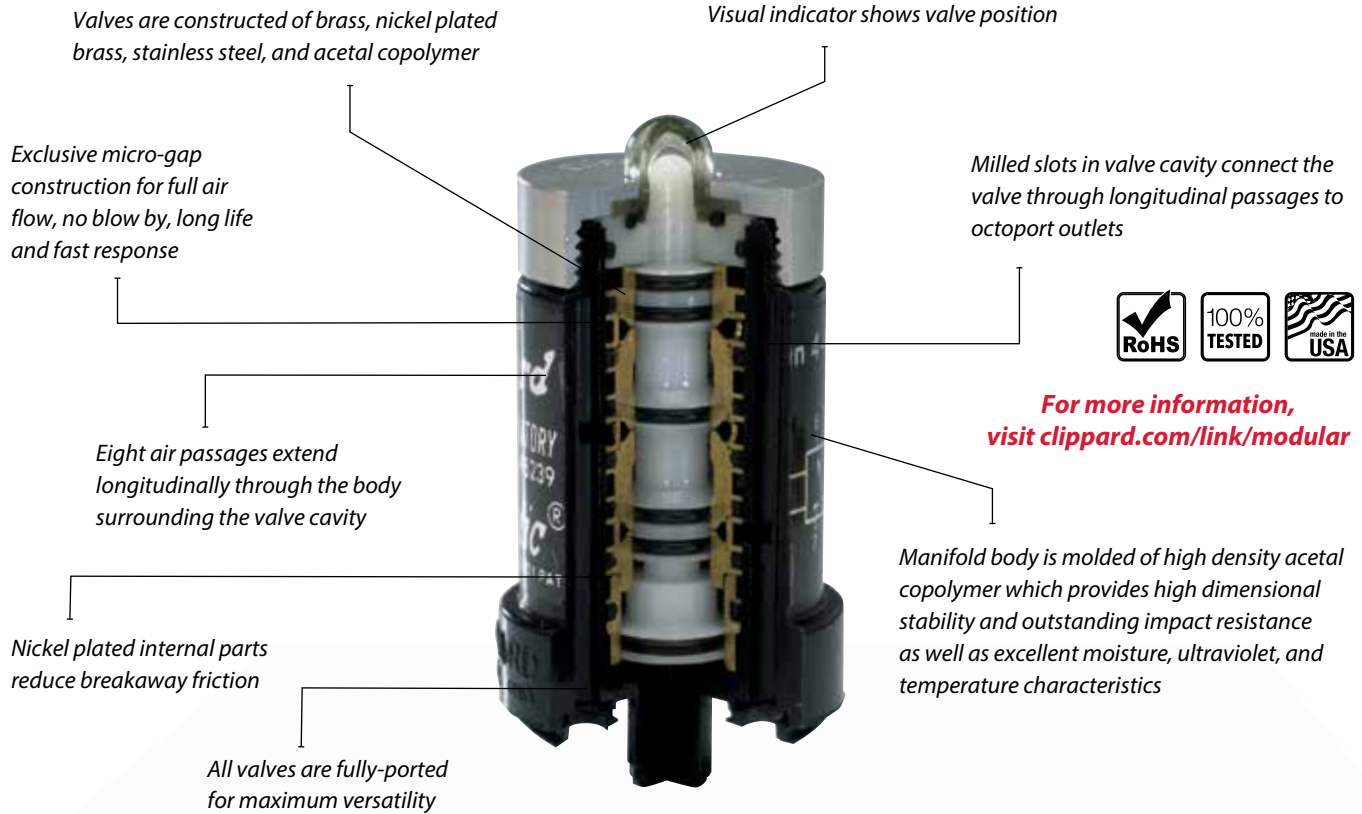

Clippard modular valves can easily be configured to perfectly meet the needs of a wide variety of applications. Call 1-877-245-6247 today to discuss your requirements.

- Air pilot pneumatic valves for air, oil, or water
- Fast response and long life
- Balanced spool design
- Keyed manifold mounting
- Over 70 configurations available
- 0 to 150 psig working pressure
- 250 l/min @ 100 psig flow

OCTOPORT CODING

The coding method shown here is frequently used to identify port usage for different variations of Clippard modular valves. Letters are used to identify the supply or signal (S), the output (O), the exhaust (E), and the pilot input (P).

Many modular valves have multiple ported supplies, outputs, or exhausts. If duplicate ports are indicated, one may be marked with an X to indicate that it needs to be plugged. Both/either of the duplicate ports may be used, but unused duplicate ports must be plugged.

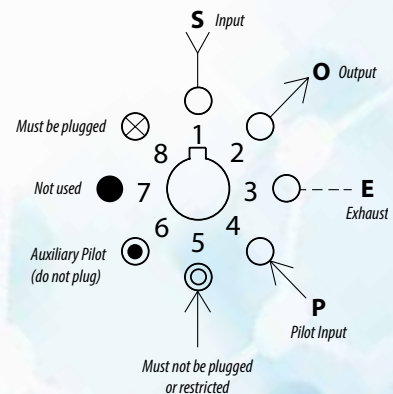

MODULAR VALVES

PNEUMATIC CIRCUIT MODULES

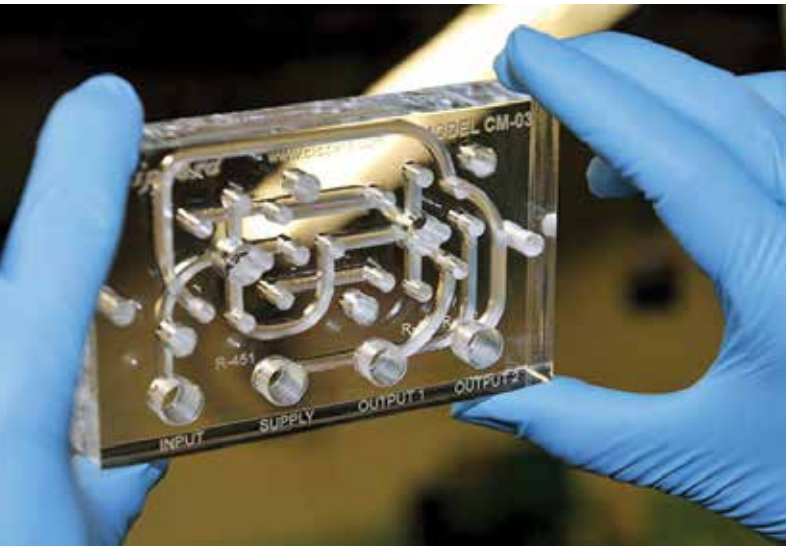

Clippard modular valves are available in an unlimited variety of directional, flow, pressure and special control valves, each in a valve body designed to mount and link together with a simple piping system. This system eases assembly and plumbing, resulting in reduced labor costs, fewer errors in installation, and less potential for plumbing leakage. Multiple valve elements can be contained in a single body, providing incredible flexibility and variety to accomplish a myriad of control challenges. Minimatic® modular valves are the supreme “plug-and-play” devices for pneumatic applications.

Versatility is the key when it comes to Clippard **modular valves**

MOST POPULAR STANDARD CIRCUIT MODELS

- VA-03 Binary Redirect Module (“Flip-Flop Circuit”)
- VA-011 Oscillator Module or Auto-Cycling of a Single-Acting Cylinder
- VA-08 Module for Single Input Clamp Control
- VA-023 Two-Hand, No-Tie-Down (THNTD) Circuit
- VA-034 Add-On Module Provides Back Pressure Latch Control
- VA-038 Two-Hand, No-Tie-Down Circuit with Latching Control
- VA-028 Auto-Cycling of Double-Acting Cylinder, 2 Valves
- VA-06 Auto-Cycling of Double-Acting Cylinder, 3 Valves
- VA-031 Back Pressure Sensing for Double-Acting Cylinder
- VA-033 Back Pressure Sensing with a Double-Acting Cylinder Using External Power Valve

For more information, schematics and drawings, visit clippard.com/link/modular



SPEEDY CIRCUIT ASSEMBLY

You can have a faster, more dependable way to produce multiples of the same pneumatic circuit!

Clippard's modular valve system enables speedy assembly while assuring accurate connections. By utilizing Clippard's unique manufacturing process, these clear acrylic subplates provide sealed passageways between valves without the need for gaskets, clamps, or piping. **It's the fastest, most efficient circuit system available!**

MODULAR VALVES

MOUNTING SUBPLATES & STRIPS



Acrylic subplates provide for up to three modular valves with various port options. Metallic plates mount to standard mounting strips.

Part No.	Valves	Port(s)	Material	Length	Width	Height	Mounting
R-101	1	-	Metallic	1.625"	2.500"	0.375"	#10-32
R-111	1	-	Metallic	1.734"	1.734"	0.437"	#10-32
CM-04	1	#10-32	Acrylic	3.000"	3.000"	0.625"	(2) 0.196" dia.
CM-02	1	1/8" NPT	Acrylic	3.500"	3.000"	0.625"	(2) 0.196" dia.
CM-036	2	1/8" NPT	Acrylic	7.000"	3.000"	0.625"	(4) 0.196" dia.
CM-037	3	1/8" NPT	Acrylic	10.75"	3.000"	0.625"	(4) 0.196" dia.

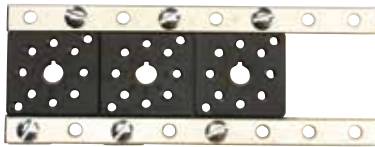

MOUNTING STRIPS & STANDOFF DIMENSIONS

For providing space beneath assembled group of modules, use R-106 (order R-107-20, packet of four with hardware). Provides 2" clearance from enclosure wall for piping with Clippard fittings and tubing. Keeps piping and installation neat.

R-107-20

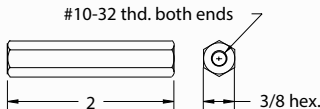

When metallic subplates are mounted to mounting strips, the components build into a strong, rigid assembly. Because of extra tolerance in the holes, note that strips may be adjusted before screws are fully tightened. This permits accurate alignment of subplates. The identifying number following the second dash in the part number indicates the number of modules the strip will accommodate while still proving a

short extension with one hole at both ends in mounting the assembly to stand-offs or other structures. The strip will accommodate one additional

module if no extensions for mounting are needed. (Every two holes will accept a subplate.)

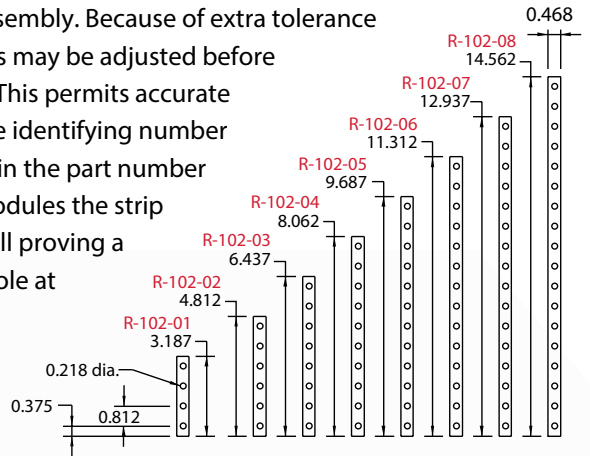

Adding Value is Our Business

Clippard's Integrated Solutions team designed a simple, straight-forward approach for piloting process valves. This assembly greatly simplifies installation and ease-of-use for the OEM design engineer.

Clippard has a unique advantage by providing custom products and value-added assemblies based on the most successful miniature pneumatic line in the world.



Clippard has designed and manufactured thousands of custom manifolds and assemblies based on specific customer requirements.

MODULAR VALVES

STANDARD CIRCUIT MODELS

BINARY REDIRECT MODULE ("Flip-Flip" Circuit)

Input signal alternates outputs A and B, sometimes referred to as a push-on/push-off circuit. The circuit manifold combines the R-451 and R-412 in a binary redirect or flip-flop circuit. Use of the R-412 provides a "memory" function to return the output to known position (port 8 whenever air is first turned on to the circuit. This output pilots port 4 of the R-451, positioning it for the next signal. A signal input passes through the R-451, ports 1 to 2, and pilots port 4 of the R-412. The output of the R-412 shifts to port 2 and also pilots port 6 of the R-451. When the next signal input is received, it passes through the R-451, ports 1 to 8, and pilots port 6 of the R-412, shifting its output back to port 8.

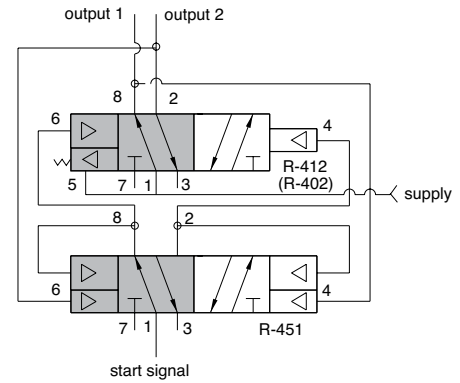

Pressure Range 40 to 150 psig

Part No.	Description
----------	-------------

VA-03 Binary Redirect Module

Circuit includes one R-451 valve, one R-412 valve, one CM-03-PQ circuit manifold, and fittings

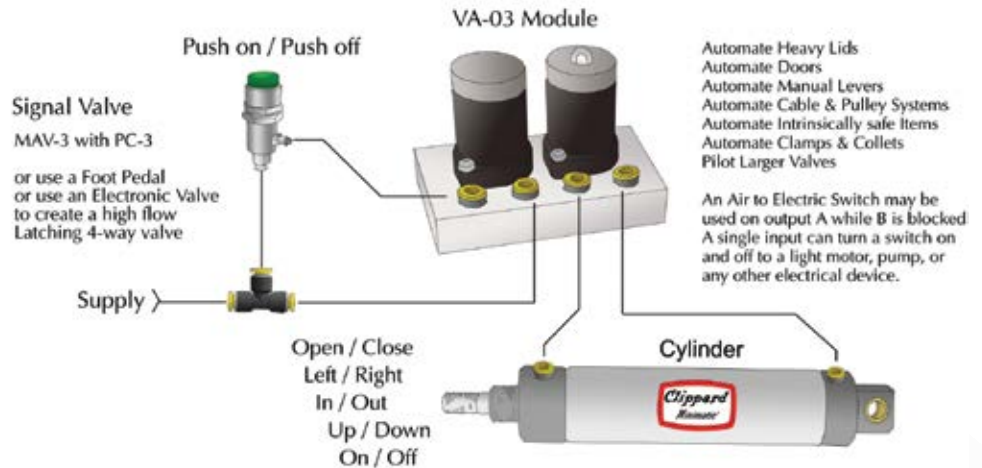

OSCILLATOR / AUTO-CYCLING MODULE

The VA-011 module is designed to use an "on-off" toggle valve (or alternative input) for an oscillating output that can be used to actuate a single-acting cylinder. With no start input, the cylinder will remain in a retracted position. Turning on the start input signal causes each valve to shift upon the others output signal. The output "on time" can be adjusted for longer or shorter times, and the "off time" is also adjustable.

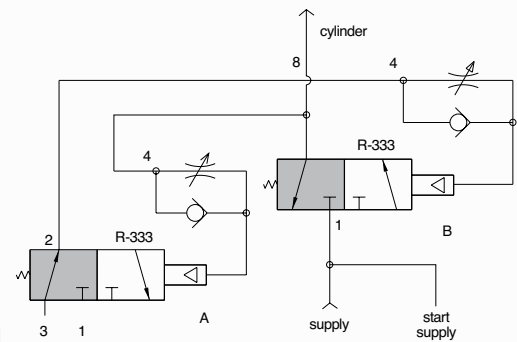

Pressure Range 40 to 150 psig

Part No.	Description
----------	-------------

VA-011 Oscillator or Auto-Cycling Module

Circuit includes two R-333 valves, one CM-011-PQ circuit manifold, fittings, and tubing

MODULAR VALVES

STANDARD CIRCUIT MODELS

MODULE FOR SINGLE INPUT CLAMP CONTROL

Uses a single input (from pneumatic foot pedal or button) to provide a simple and clean “open/close” clamp control with adjustable pressure and speed controls. “Auto-reset” feature ensures when supply is turned on, clamp will always go to the open position.

- Saves time and reduces cost and labor of piping
- Automates product tasks with easy-to-apply unit
- Provides binary push-button operation and built-in speed control
- Pressure regulation included
- May be operated remotely



Circuit includes one R-402 valve, one R-412 valve, one R-451 valve, one R-701 valve, one CM-08-PQ circuit manifold, one MNV-1KP valve, one pressure gauge, one noise muffler, fittings, and tubing.

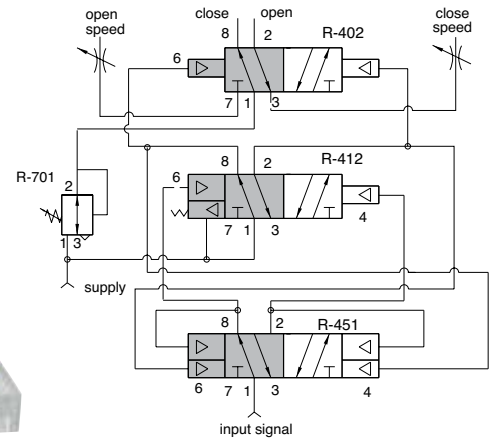

Pressure Range 40 to 150 psig

Part No.	Description
VA-08	Module Only
VA-08-FP	Module with Foot Pedal Actuator
VA-08-GN	Module with Green Palm Button

AUTO-CYCLING OF A DOUBLE-ACTING CYLINDER



Circuit includes one R-333 valve, one R-453 valve, one TV-3S valve, one CM-028-PQ circuit manifold, fitting adapter, fittings and tubing

Similar to the VA-06, this is a more compact version designed for automatic cycling of double-acting cylinders without the use of limit valves or a magnetic sensor. This circuit enables a double-acting cylinder to reciprocate without the use of limit valves and to control its speed in each direction. The two R-333 and R-453 valves also incorporate adjustable delay features that will control the time between retract and extend cycles.

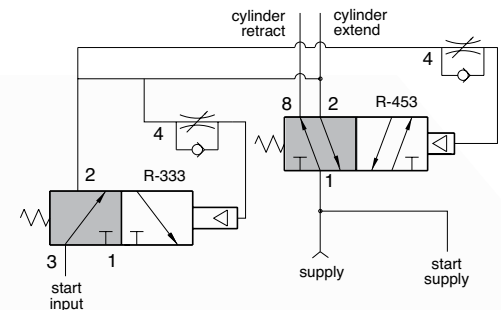

Pressure Range 40 to 150 psig

Part No.	Description
VA-028	Auto-Cycling Module

BACK-PRESSURE SENSING FOR DOUBLE-ACTING CYLINDER



Circuit includes one R-333 valve, one R-453 valve, one TV-3S valve, one CM-028-PQ circuit manifold, fitting adapter, fittings, and tubing

Very versatile for controlling a double-acting cylinder without limits. The circuit uses back pressure to send a signal when the cylinder finishes moving. This module is ideal for integrating into a larger circuit with electronic valves or all pneumatic components.

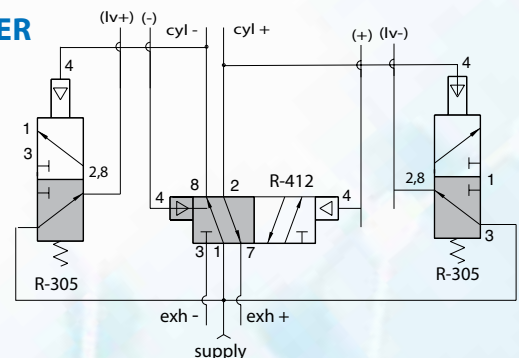

Pressure Range 40 to 150 psig

Part No.	Description
VA-031	Back Pressure Sensing Module

MODULAR VALVES

STANDARD CIRCUIT MODELS

TWO-HAND, NO-TIE-DOWN (THNTD) CIRCUIT

This module is a self-contained circuit board with all interconnections required to provide a Two-Hand, No-Tie-Down (THNTD) pneumatic circuit. The main function of this control is to require a machine operator to use both hands at the same time to actuate the equipment, helping to insure that the operator's hands are not in a position to be injured by the machine as it is in motion.

Enables simple, rapid installation of a pneumatic Two-Hand, No-Tie-Down pneumatic circuit

For more information, visit clippard.com/link/thntd

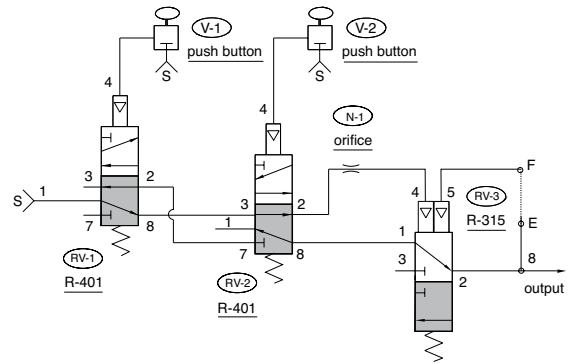

Absolutely no alterations or modifications should be made to this circuit or its components parts.

Pressure Range 50 to 120 psig

Part No.	Description
VA-023	THNTD Circuit, No Palm Buttons
VA-023-GN	THNTD Circuit with 2 Green Palm Buttons
VA-023-RD	THNTD Circuit with 2 Red Palm Buttons

Circuit includes one R-315 valve, two R-401 valves, one CM-023-PQ circuit manifold, fittings, and tubing



RV-3 is held open by supply air that passes through RV-1, RV-2 and N-1. When RV-1 is actuated alone, the pilot air for RV-3 flows back through the N-1 and RV-2 to atmosphere at RV-1, and RV-3 is closed by the spring. When RV-2 is actuated alone, the same sequence occurs except the pilot air from RV-3 exhausts to atmosphere via RV-2.

Restriction N-1 determines the time span during which both signals must be received in order to obtain the output. When RV-1 and RV-2 are actuated together, supply air is directed through RV-1, RV-2 and RV-3 to the output, providing a momentary output signal that is determined by N-1. If a maintained signal is required, a jumper between E and F maintains an output as long as the operator is depressing both palm buttons.

The indicator on RV-3 (R-315) must be down for an output to be obtained. If either RV-1 or RV-2 is actuated separately, their respective indicator will go up, but after approximately one second, the indicator on RV-3 (R-315) will go down showing that the valve has shifted and an output cannot be obtained. Circuit performance and sequence should be periodically observed to verify proper function.

LIMITED WARRANTY

When properly used, this equipment meets ANSI B11.1-1971 and OSHA 1910.217 safety standards for Two-Hand, No-Tie-Down controls. It is the buyer's sole responsibility to determine proper application, location installation, use and maintenance of this equipment. This equipment performs the function of a Two-Hand, No-Tie-Down control only. All other prescribed safety devices must be used with this equipment. Seller shall not be responsible for any failure to so comply which results from the application, installation, location, operation, use or maintenance of this equipment or from alteration of the equipment by persons other than the seller, or from design or instruction furnished by the buyer or his agents.

Sellers liability shall be limited to replacement or modification of the equipment to comply with OSHA standards or to refund the purchase price. Seller will be responsible for any fines, penalties or consequential damage. Clippard makes no other warranty of any kind, expressed or implied.

MODULAR VALVES

STANDARD CIRCUIT MODELS

BACK PRESSURE LATCH CONTROL

The VA-034 module is for operation of a clamp or collet system where Two-Hand, No-Tie-Down (THNTD) input is required to be held continuously until the position desired (limit valve) is fully engaged. THNTD circuit is re-engaged to release the clamp mechanism.

Output of the CM-023 or VA-023 goes to the VA-034 module and begins to extend cylinder. The two palm buttons on the THNTD must remain actuated until the limit valve is actuated or unit will retract the cylinder. When the cylinder has depressed the limit valve, the unit locks the valve, and the cylinder continues to see pressure on the extend port. The unit is latched and buttons can now be released. A second input from the CM-023 or VA-023 (depressing both buttons) will now release the latch and retract the cylinder to the starting position as shown, and the circuit is ready for another operation.

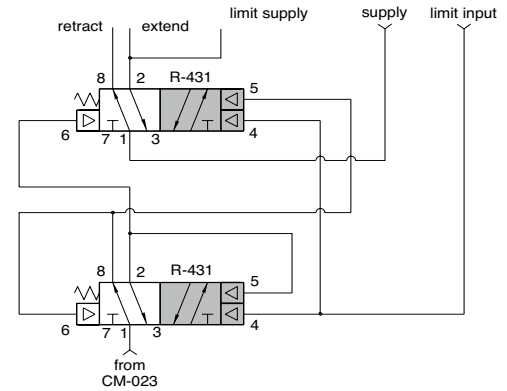

Pressure Range 40 to 150 psig

Part No.	Description
VA-034	Back Pressure Latch Control for VA-023

Circuit includes two R-431 valves, one CM-034-PQ circuit manifold, fittings, and tubing

TWO-HAND, NO-TIE-DOWN CIRCUIT WITH LATCHING CONTROL

The VA-038 module is for operation of a clamp or cylinder operation where Two-Hand, No-Tie-Down (THNTD) input is required to be held continuously until the position desired (limit valve) is fully engaged. The THNTD circuit releases the latch and returns the cylinder to the retracted position.

The two palm buttons on the THNTD must remain actuated until the limit valve is actuated, or the unit will retract the cylinder. When the cylinder has depressed the limit valve, the unit locks the valve, and the cylinder continues to see pressure on the extend port. The unit is latched, and buttons can now be released. A second input from depressing both buttons will now release the latch and retract the cylinder to the starting position as shown, and the circuit is ready for another operation.



Pressure Range 40 to 150 psig

Part No.	Description
VA-038	Module Only, No Palm Buttons
VA-038-GN	Module with 2 Green Palm Buttons
VA-038-RD	Module with 2 Red Palm Buttons

Circuit includes two R-431 valves, two R-401 valves, one R-315 Valve, one CM-038-PQ circuit manifold, two palm buttons (as ordered), fittings, and tubing

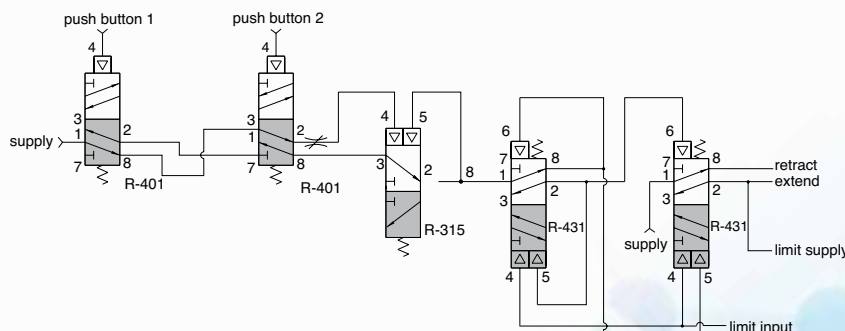

MODULAR VALVES

STANDARD CIRCUIT MODELS

AUTO-CYCLING OF A DOUBLE-ACTING CYLINDER

The VA-06 module is designed to use an “on-off” toggle valve (or alternative input) for the cycling of a double-acting cylinder without the use of limit valves.

This circuit enables a double-acting cylinder to reciprocate without the use of limit valves and to control its speed in each direction. The two R-343 valves also incorporate adjustable delay features that will control the time between retract and extend cycles. With the miniature needle valves, the speed of the cylinder is also adjustable for your application.

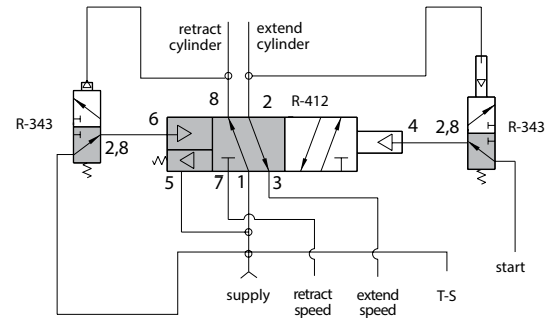

Pressure Range 40 to 150 psig

Part No.	Description
VA-06	Auto-Cycling Module

Circuit includes two R-343 valves, one R-412 valve, one TV-3S valve, one MNV-1KP valve, one CM-06-PQ circuit manifold, mufflers, adapter, fittings, and tubing

BACK PRESSURE SENSING WITH A DOUBLE-ACTING CYLINDER USING EXTERNAL POWER VALVE

The VA-033 module is very similar to the VA-031 for controlling a double-acting cylinder without limits. The circuit uses back pressure to send a signal when the cylinder finishes moving. This module is designed to be used in conjunction with an external power valve.

This circuit enables feedback from the external valve outputs to signal back to the module ports (CYL+ and -) when back pressure is building. Utilizing ports TS and FS allows you to loop them back to the module’s inputs, and create an auto-cycling circuit using back pressure, as opposed to a timing signal (such as the VA-06 module). You can also choose to use the output to go to a manual button, pneumatic delay valve, electronic valve and PLC, or pneumatic sequencer (such as a R-932 circuit) and allow those options to signal back to the module to begin the next cycle.

For assistance with selecting or configuring Clippard pneumatic circuit modules for your application, call **877-245-6247**.

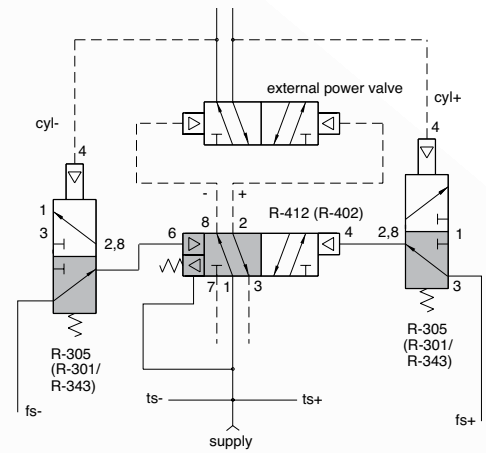

Pressure Range 40 to 150 psig

Part No.	Description
VA-033	Back Pressure Module

Circuit includes two R-305 valves, one R-412 valve, one CM-033-PQ circuit manifold, fittings, and tubing

MODULAR VALVES

3-WAY PILOT VALVES

Normally-Closed, Normally-Open, Selector, Diverter

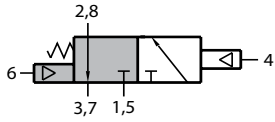

Normally-Closed shown

R-301

3-Way spring return, fully-ported

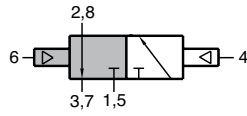

Normally-Closed shown

R-302

3-Way double pilot, fully-ported

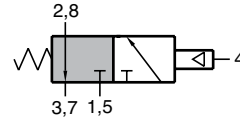

Normally-Closed shown

R-305

3-Way, spring return, fully-ported with low pressure pilot

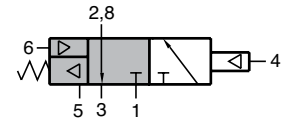

Normally-Closed shown

R-310

3-Way, fully-ported with special spring reset to return to preset position when pressure is lost

3-WAY PILOT VALVES

Normally-Closed, Normally-Open, Selector, Diverter

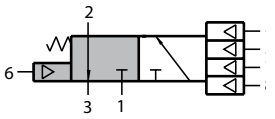

Normally-Closed shown

R-311

3-Way spring return, fully-ported with 4 pilots; any will actuate valve

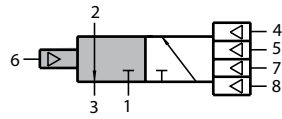

Normally-Closed shown

R-312

3-Way fully-ported with 1 pilot on side and 4 pilots on opposite side; any will actuate valve

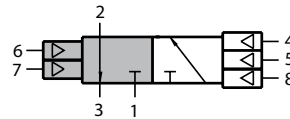

Normally-Closed shown

R-314

3-Way, fully-ported with 2 pilots on side and 3 pilots on opposite side; any will actuate valve

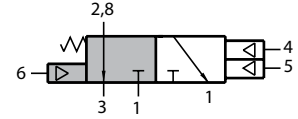

Normally-Closed shown

R-315

3-Way, spring return, fully-ported with 2 pilots, either will actuate valve, and aux. pilot on spring side

3-WAY COMBINATION VALVES

Normally-Closed, Normally-Open, Selector, Diverter

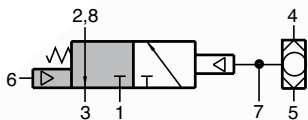

Normally-Closed shown

R-321

3-Way spring return, fully-ported with shuttle valve on the pilot

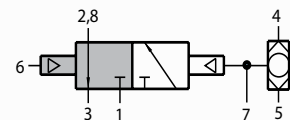

Normally-Closed shown

R-322

3-Way fully-ported with shuttle valve on 1 sides pilot

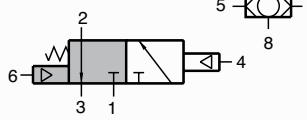

Normally-Closed shown

R-323

3-Way, spring return, fully-ported with independent shuttle valve in the same body

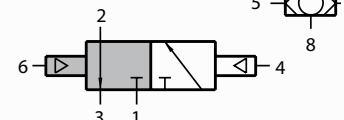

Normally-Closed shown

R-324

3-Way fully-ported with independent shuttle valve in body

3-WAY 2-POSITION AIR PILOT DELAY VALVES

Normally-Closed, Normally-Open, Selector, Diverter

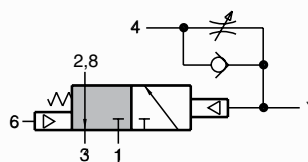

R-331/333

Delay "In" function will allow a signal at port 4 to delay through an adjustable flow control and delay the actuation of the valve

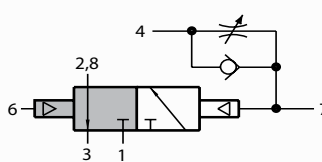

R-332/334

Delay "In" function will allow a signal at port 4 to delay through an adjustable flow control and delay the actuation of the valve. Pressure at port 6 will shift the valve back

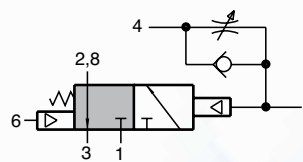

R-341/343

Delay out function will allow a signal at port 4 to shift the valve immediately. Loss of air at port 4 will delay the valve to shift to its original position



MODULAR VALVES

3-WAY SPECIALTY VALVES

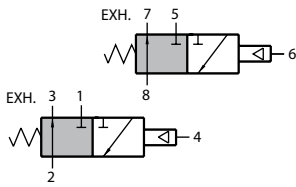

Normally-Closed Double

R-351

Combination of two independent 3-Way, Normally-Closed, 2-position spring return valves

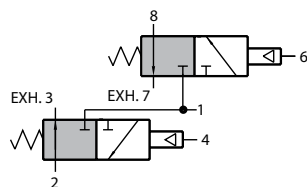

Normally-Closed Double with Common Supply

R-352

Combination of two independent 3-Way, Normally-Closed, 2-position, spring return valves with a common supply port for convenience

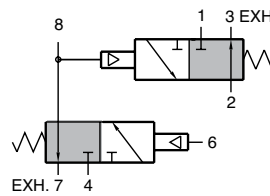

Normally-Closed Double "AND" Valve

R-353

Combination of two 3-Way, Normally-Closed, 2-position spring return valves that make up a 3-input "AND" subcircuit

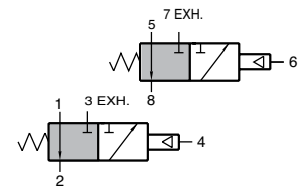

Normally-Open Double

R-355

Combination of two independent 3-Way, Normally-Open, 2-position spring return valves

4-WAY SINGLE PILOT VALVES

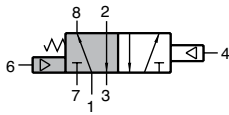

R-401/R-402

4-Way, fully-ported, 2-position. R-401 is a spring return valve

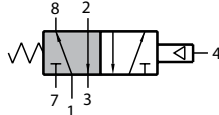

R-405

4-Way, spring return, fully-ported with low pressure pilot

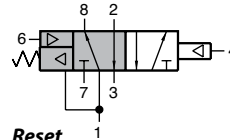

Reset

R-412

4-Way fully-ported, 2-position double air-pilot valve with a return to home when supply air is exhausted

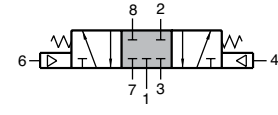

3-Position

R-421

4-Way fully-ported 3-position spring to center valve

4-WAY MULTI-PILOT VALVES

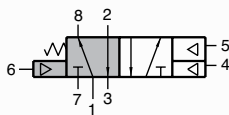

R-431

5-ported, 4-Way spring return, dual pilot. Indicator shows valve in shaded position.

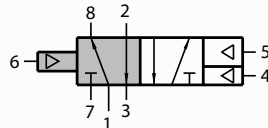

R-432

5-ported, 4-Way dual pilot. Indicator shows valve in shaded position.

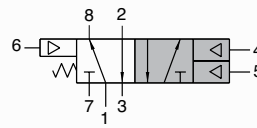

R-433

5-ported, 4-Way spring return, dual pilot. Indicator shows valve in shaded position.

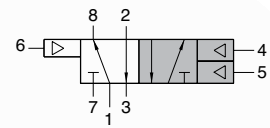

R-434

5-ported, 4-Way dual pilot. Indicator shows valve in shaded position.

4-WAY DELAY PILOT VALVES

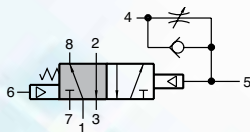

R-443

4-Way spring return, fully-ported with adjustable flow control. Metered "Out" on pilot

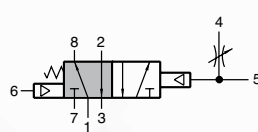

R-445

4-Way spring return, fully-ported with adjustable needle valve connected to pilot

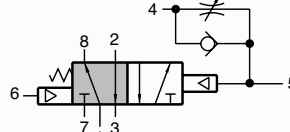

R-453

4-Way spring return, fully-ported with adjustable flow control. Metered "In" on pilot

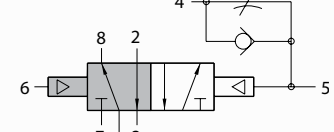

R-454

4-Way fully-ported with adjustable flow control. Metered "In" on pilot

MODULAR VALVES

4-WAY SPECIALTY VALVES

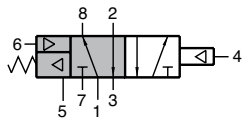

R-410
4-Way, fully-ported with special spring reset to return to preset position when pressure is lost

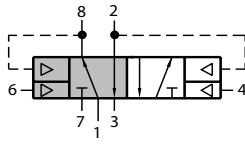

R-451
4-Way for use with R-402/R-412 in "Flip-Flop" circuit

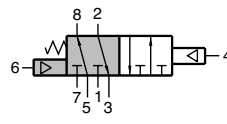

R-461
4-Way spring return, 6-ported

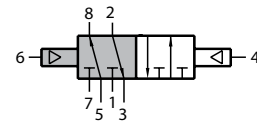

R-462
4-Way, 6-ported

4-WAY SPECIALTY VALVES

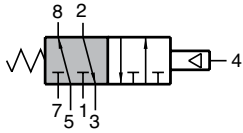

R-465
4-Way spring return, 6-ported with low pressure pilot

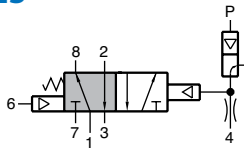

R-471
4-Way spring return, fully-ported with amplified pilot

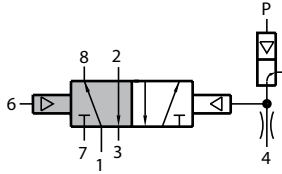

R-472
4-Way fully-ported with amplified pilot

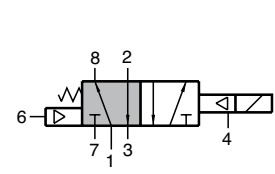

R-481
4-Way spring return, fully-ported, piloted by Clippard ET-3 valve

SPECIALTY VALVES

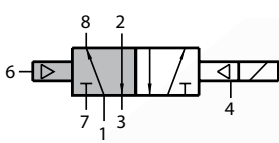

R-482
4-Way, fully-ported, piloted by Clippard ET-3 electronic valve

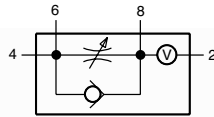

R-501 (shown)/502
Flow control valves. R-501, Delay in, R-502, Delay out

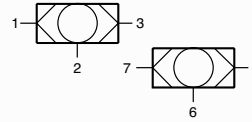

R-602 (shown)/603
Dual shuttle valves. R-603, 3 input "OR"

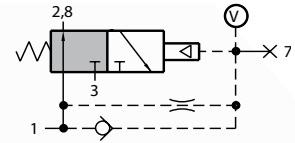

R-711
Pulse valve, Normally-Open

SEQUENCE VALVE

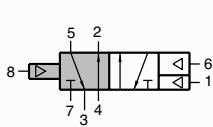

R-932
Sequence valve

4-WAY BLEED PILOT

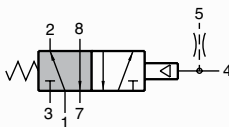

R-441
4-Way spring return, fully-ported with bleed pilot for low force sensors

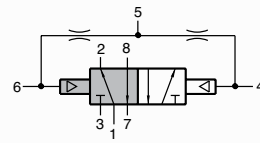

R-442
4-Way, fully-ported with bleed pilots for low force sensors

SUBPLATE CONNECTOR



R-811
Connector to subplate R-101, R-111 and manifolds

FILTER MODULE

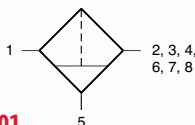

R-801
Filter Module, 25 micron

VOLUME CHAMBER

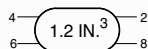

R-821
Volume Chamber, 1.2 cubic inch

WORLDWIDE DISTRIBUTION

Clippard products are distributed through our worldwide network of sales and engineering specialists. All of our representatives are stocking distributors and keep a variety of Clippard products on hand to fill your immediate needs. Each of our distributors are backed by our own large inventory to ensure quick delivery.

To locate your nearest distributor, call **877-245-6247** or visit clippard.com/distributors



CORPORATE OFFICE

United States ISO 9001:2015
7390 Colerain Avenue
Cincinnati, OH 45239
877-245-6247



United States ISO 9001:2015
4141 Thunderbird Lane
Fairfield, OH 45014
877-245-6247
clippard.com



Belgium
Parc Scientifique Einstein; Rue du Bosquet
B-1348 Louvain-la-Neuve-Sud
32-10-45-21-34
clippard.eu



China
3-1107, No. 599 Jianzhu Road
Wuxi, Jiangsu
86-137-9527-9010
zh.clippard.com



LIMITED WARRANTY

Clippard Instrument Laboratory, Inc. (seller) warrants its products to be free from defects in material and workmanship for a period of one (1) year from the date of sale. Seller's liability shall be limited at seller's option to repair, replacement or refund of purchase price of product found by seller's examination to be defective. All claims under this warranty must be made in writing to seller's factory sales department giving full details, prior to return of product, postpaid, to factory. Seller shall not be responsible for product failure due to normal wear, accident, buyer's misapplication, abuse, neglect or alteration of product. Seller will not be responsible for any consequential damages. Clippard Instrument Laboratory, Inc. makes no other warranty of any kind, expressed or implied. Circuits shown in this catalog are for instructional purposes only. All circuits and components used on equipment and machinery should be thoroughly tested by qualified personnel under actual working conditions to determine their suitability for buyer's intended use. All technical data and operations are average values based on standard production models. Some deviations can be expected and considerations should be given during initial design stages. All operating characteristics are based on new equipment, under normal conditions of use and environments and oil free air supply. Dimensions stated may be nominal and are subject to change without notice. Contact Clippard for specific dimensional tolerances when dimensions are critical. Clippard®, Maximatic®, and Minimatic® are registered trademarks of Clippard Instrument Laboratory, Inc.

CA PROPOSITION 65

All products shipped to or sold to consumers in California include Proposition 65 documentation with the shipment and reference our website. There are over nine hundred (900) chemicals on the Proposition 65 list, some of which are used in Clippard materials and/or processes. Although not all products contain chemicals within the list, Clippard is being cautious and diligent in complying with the California Law.

As of August 30, 2018, chemicals we are aware of that are listed within Proposition 65 are detailed online at clippard.com/link/prop65, or for additional information please contact tech@clippard.com.